

Synthesis and crystal structure of the 16 e⁻ cationic tungsten(IV) complex [WCp*(4,4'-Me₂bipy)Cl₂]⁺BPh₄⁻ †

Christian Cremer and Peter Burger *

Anorganisch-chemisches Institut der Universität Zürich, Winterthurerstr. 190, 8057 Zürich, Switzerland. E-mail: chburger@aci.unizh.ch

Received 16th December 1998, Accepted 23rd April 1999

A general synthetic route to electron rich half-sandwich tungsten(IV) complexes with a series of 4,4'-disubstituted 2,2'-bipyridyl (R₂bipy) donor ligands of the type [W^{IV}Cp*(R₂bipy)Cl₃] has been elaborated. The crystal structure and conductivity measurements of the R = methyl derivative evidenced quite weak bonding of the chloride ligands in these complexes. This propensity has been utilized to prepare the novel square pyramidal, 16e⁻ Lewis acid [WCp*(Me₂bipy)Cl₂]⁺BPh₄⁻ through halide abstraction from [WCp*(Me₂bipy)Cl₃] with NaBPh₄. The crystal structures of the cationic complex and its 18e⁻ CO adduct [WCp*(Me₂bipy)(CO)Cl₂]⁺BPh₄⁻ obtained through carbon monoxide addition to the former have been determined.

Introduction

The chemistry of monocyclopentadienyl (Cp) transition metal halide complexes is in general well developed and has quite recently been reviewed by Poli.¹ His group has largely contributed to and in particular extended the chemistry of half-sandwich Cp molybdenum complexes in higher oxidation states, *i.e.* Mo^{IV-VI}.²⁻⁸ For the higher tungsten homologue there have been numerous publications from the groups of Schrock and Green mostly dedicated to tungsten in its W^{III,VI} oxidation state.⁹⁻¹⁷ The latter compounds have frequently been obtained from the very versatile and readily available starting materials [W(CpR)Cp*Cl₄].^{1,9-19}

On the other hand, little was known about tungsten(IV) half-sandwich complexes when we started to work in this area.²⁰⁻²⁵ To the best of our knowledge, the single electron reduction of [W(CpR)Cp*Cl₄] to yield "[W(CpR)Cp*Cl₃]" had so far not been carried out with success; Schrock *et al.*¹⁷ have even provided some limited evidence that "[WCp*Cl₃]" might undergo disproportionation to tungsten(-III) and (-V) species. Related redox chemistry of the PMe₃ adduct of [WCp*Cl₄], [WCp*Cl₄(PMe₃)], in the presence of phosphine donors has recently been described by Baker *et al.*²³ It is noteworthy that the corresponding molybdenum(IV) complex "[MoCp*Cl₃]" has very recently been prepared by Poli and co-workers⁴ by a one-electron reductive route from [MoCp*Cl₄]. The crystal structure analysis showed that the molybdenum(IV) compound is actually a doubly μ-chloride bridged dimer, *i.e.* [{MoCp*Cl₂(μ-Cl)}₂], which can be cleaved to monomeric complexes by addition of phosphine ligands.⁴

In the search for a route to electron rich half-sandwich tungsten(IV) complexes with a series of 4,4'-disubstituted 2,2'-bipyridyl (R₂bipy) donor ligands of the type [W^{IV}Cp*(R₂bipy)Cl₃] the aforementioned route for molybdenum seemed attractive since a common starting material, *i.e.* "[WCp*Cl₃]", could be used in these syntheses. We have hence turned to the synthesis of this material from [WCp*Cl₄] under reductive conditions and have briefly reported on its preparation and dimeric crystal structure in a recent communication.²⁶ In this publication, we will present a general route to [W^{IV}Cp*(R₂bipy)Cl₃] complexes from this hitherto unknown starting material. The crystal structures of the 4,4'-dimethylbipyridyl representative and the cationic 16e⁻

Lewis acid obtained from it through halide abstraction, *i.e.* [WCp*(Me₂bipy)Cl₂]⁺, will be reported.

Results and discussion

Since the synthesis, isolation, electronic and magnetic properties of [(WCp*Cl₃)₂] **1** will be described in some detail in a forthcoming publication, we will just briefly review some aspects of its preparation. Compound **1** can be obtained according to eqn. (1) by one-electron reduction through careful

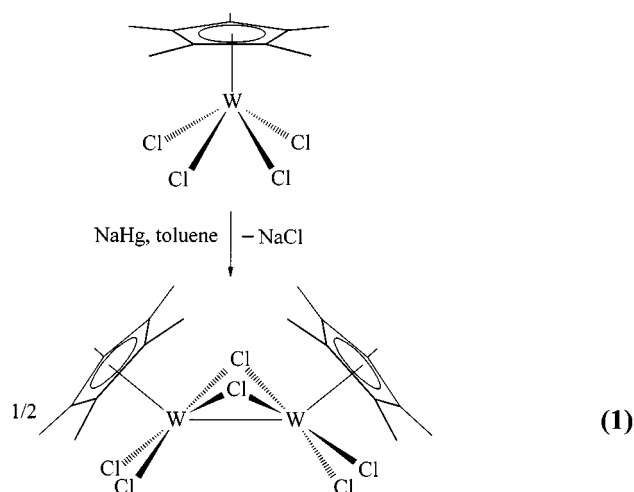

controlled addition of NaHg to [WCp*Cl₄] in toluene, to avoid formation of [(WCp*Cl₂)₂]. However, the isolation of pure compound **1** from this reaction mixture is rather cumbersome owing to its extremely high air-sensitivity and limited solubility in innocent solvents, such as toluene, which have to be used to prevent decomposition. We have therefore prepared complexes **2-R** from compound **1** generated *in situ* according to eqn. (2). Preferably, 1/2 equivalent of the mild reducing agent, the electron rich tetrakis(dimethylamino) substituted olefin, (NMe₂)₂C=C(NMe₂)₂ (TDAE), is used in this reaction.

Complexes **2-R** were prepared by this route in good to excellent yields as microcrystalline materials; depending on the bipyridyl substituent R their colours vary from yellow to dark violet (see Experimental section). Although the quite low solubility of most compounds posed some problems to their

† Monocyclopentadienyl complexes. Part 1.

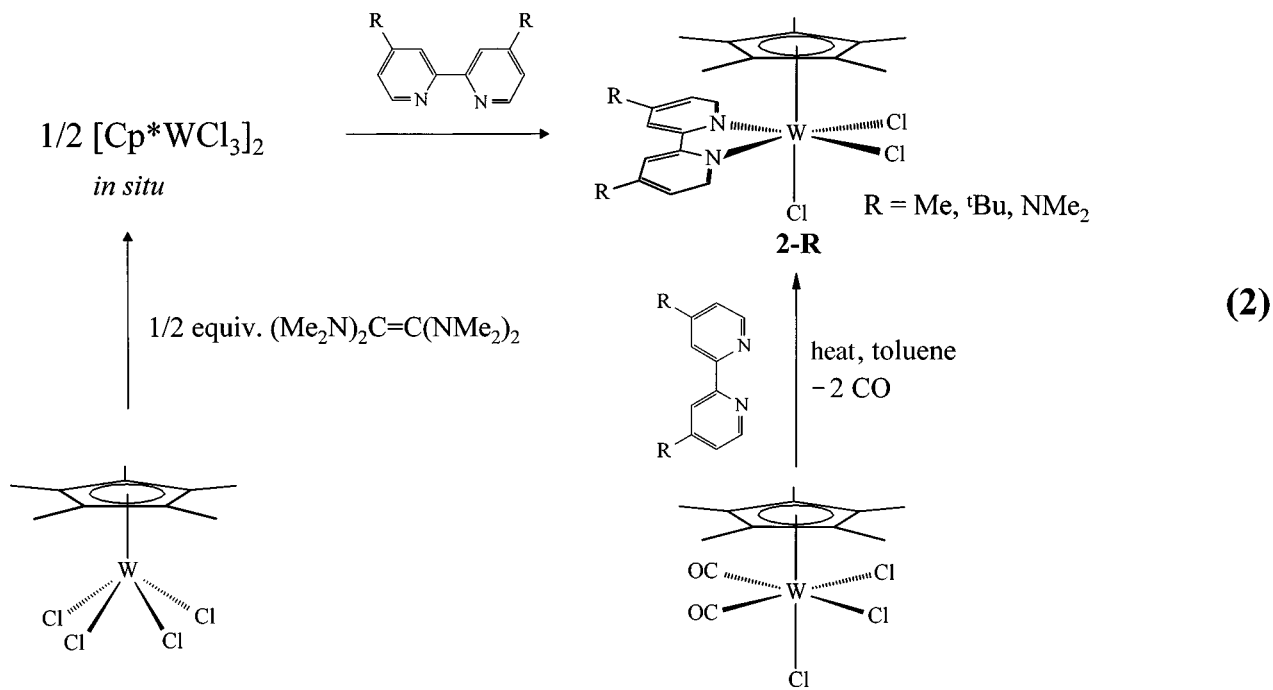

isolation pure, we have obtained correct elemental analysis data for all novel complexes **2-R** shown in eqn. (2).

The related Cp molybdenum complex to **2-R**, [MoCp(bipy)Br₃], had been reported by Haines *et al.*²⁷ some years ago and has been prepared through thermal decarbonylation of the dicarbonyl starting material, [MoCp(CO)₂Br₃], in the presence of the N-donor. Owing to the low solubility, however, this compound has been characterized only by elemental analysis. Adaptation of this synthesis for the tungsten analogues required [WCp*(CO)₂Cl₃], which just recently has become available.²⁴ The compound **2-Me** could be prepared according to this route in reasonable yield, eqn. (2).

It should be noted that the reductive pathway shown in eqn. (2) is clearly superior to the latter preparation, since isolation from carbonyl containing by-products is not required, higher overall yields are obtained and the more readily available starting material [WCp*Cl₄] can be utilized.

Analytically pure compounds **2-R** are weakly paramagnetic with magnetic moments, μ_{eff} , of 0.5–0.8 μ_{B} at RT. This explains the broad lines observed in the ¹H NMR spectra and leads in most cases to unresolved H–H coupling due to line broadening of the bipyridyl resonances. It is interesting, however, that the chemical shifts of the bipyridyl and the Cp* methyl ¹H NMR resonances are still in the expected range for the presumed diamagnetic complexes. The measurement of ¹³C NMR spectra was limited to the *tert*-butyl substituted complex **2-tBu** owing to the very low solubilities of the other complexes **2-R**. However, even at 10⁻¹ M concentration of **2-tBu** in CD₂Cl₂ at 75.1 MHz and using polarization transfer techniques, we could merely detect the rather broad resonance of the peripheral *tert*-butyl methyl groups. Hence, although the NMR data allowed only limited structural assignments, the ¹H NMR spectra provided evidence for C_s symmetry in complexes **2-R**. The chemical equivalence of the equivalent positions in the bipyridyl rings suggested that of two possible isomers (*mer* and *fac*) for **2-R** shown, only the facial isomer **a** was present in solution.

This was also in accordance with steric arguments, since an energetically less favourable structure for the meridional isomer **b** was anticipated due to steric repulsion between the Cp* and one of the bipyridyl rings. It deserves special mention, however, that in the cyclopentadienyl molybdenum series, *i.e.* for complexes of the type [MoCpL₂X₃] where L is a mono- or bi-dentate phosphine donor and X = halide, both types of isomers **a**, **b** have been observed.^{5,8,28,29} In order to establish the

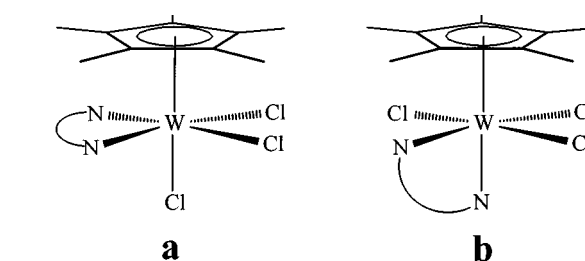

structure of complexes **2-R** unambiguously, we have therefore performed a crystal structure analysis of the methyl derivative **2-Me**.

Crystal structure of complex **2^{Et}-Me**

Although the collected data for complex **2-Me** allowed us to establish clearly the geometric arrangement around the tungsten centre as the facial isomer **a**, disorder in the Cp* rings led to severe problems with the data refinement. We have therefore prepared and collected a crystal data set for the ethyltetramethyl analogue [W(C₅Me₄Et)(Me₂bipy)Cl₃] **2^{Et}-Me**. This small variation allowed us to obtain better data and to solve and refine the molecular structure of **2^{Et}-Me** which is presented in Fig. 1. Selected bond distances and angles are given in Table 1.

Although the W central atom in complex **2^{Et}-Me** is formally eight-co-ordinate, the structure is described better in terms of a pseudo-octahedral geometry with the ethyltetramethylcyclopentadienyl (C₅Me₄Et) ligand occupying one co-ordination site. The equatorial plane then includes the nitrogen atoms of the 4,4'-dimethylbipyridyl (N1, N2) and the Cl ligands, Cl1 and Cl2. This is best illustrated through the Cl3–W1–Z1 angle of 174.8° (Z1 = ring centroid). Notably, we observed significant variations in the W–C_{Cp} bond lengths (Table 1) which are in the range of 2.244(9) to 2.453(8) Å. Distortions of this type have been observed by Poli and co-workers⁶ in the crystal structures of Cp molybdenum complexes and have been interpreted in electronic terms, *i.e.* W–Cp δ bonding.³¹ Since additional bending of the Cp-ring substituents out of the cyclopentadienyl ring plane away from the metal centre is observed, we anticipate that steric congestion at the metal centre is also contributing. However, by comparison with tungsten–chlorine bonds in other 18 e⁻ tungsten complexes,³² the most prominent feature of this

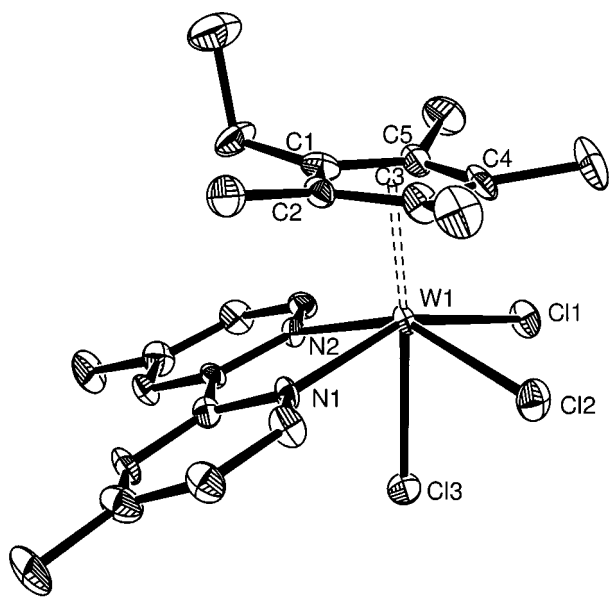

Fig. 1 An ORTEP³⁰ plot of complex **2^{Et}-Me** (ellipsoids are at the 50% probability level).

Table 1 Selected bond distances (Å) and angles (°) with estimated standard deviations (e.s.d.s) for complex **2^{Et}-Me**

W1–Cl1	2.487(2)	W1–Cl2	2.470(2)
W1–Cl3	2.534(7)	W1–N1	2.163(7)
W1–N2	2.164(7)	W1–C1	2.436(8)
W1–C2	2.453(8)	W1–C3	2.345(9)
W1–C4	2.244(9)	W1–C5	2.307(8)
W1–Z1 ^a	2.20	C–C (Cp*) _{av}	1.423(12)
Cl1–W1–Cl2	85.7(1)	Cl1–W1–Cl3	76.7(1)
Cl2–W1–Cl3	77.7(1)	Cl1–W1–N1	151.0(2)
Cl1–W1–N2	92.8(2)	Cl2–W1–N1	91.1(2)
Cl3–W1–N1	74.4(2)	Cl3–W1–N2	72.5(2)
Cl3–W1–N1	74.4(2)	Cl3–W1–N2	72.5(2)
N1–W1–N2	75.8(3)	Cl1–W1–Z1	106.3
Cl2–W1–Z1	106.5	Cl3–W1–Z1	174.8
N1–W1–Z1	102.3	N2–W1–Z1	103.0

^a Z1 is the midpoint of carbon atoms C1 to C5.

trichloro complex is the rather long W–Cl bond distances [W1–Cl1 2.487(2), W1–Cl2 2.470(2) Å] with the Cl ligand Cl3 in “*trans*” position to the C₅Me₄Et group having an even 5 pm longer W–Cl bond [W1–Cl3 2.534(7) Å]. Considering the pronounced elongation of the W–Cl bonds, we anticipated that facile ionization of the unique Cl3 ligand might occur in solution and have hence turned to conductivity measurements which are described in the next paragraph.

Conductivity measurements

Ionization of one of the Cl ligands would lead to the equilibrium (3). The results of a concentration dependent molar



conductivity study for **2-Me** in CH₂Cl₂ solution presented in Fig. 2 clearly established that **2-Me** is only partially dissociated at 10^{−3} M concentration ($A_m = 1.4 \text{ S cm}^2 \text{ mol}^{-1}$, $c = 10^{-3} \text{ M}$) and therefore is *not* a 1:1 electrolyte. However, in full agreement with the equilibrium (3), complex **2-Me** behaves as an ionophore³³ and is *completely* dissociated at low concentrations ($c < 10^{-5} \text{ M}$, $A_m = 32 \text{ S cm}^2 \text{ mol}^{-1}$ at $5 \times 10^{-6} \text{ M}$). The outcome of these measurements suggested that the cationic complexes [WCp*(R₂bipy)Cl₂]⁺ had indeed some *inherent* stability. Owing to the latter considerations and, also, since these cations were deemed synthetically valuable Lewis acids, we made efforts to establish the synthetic access to this type of compounds.

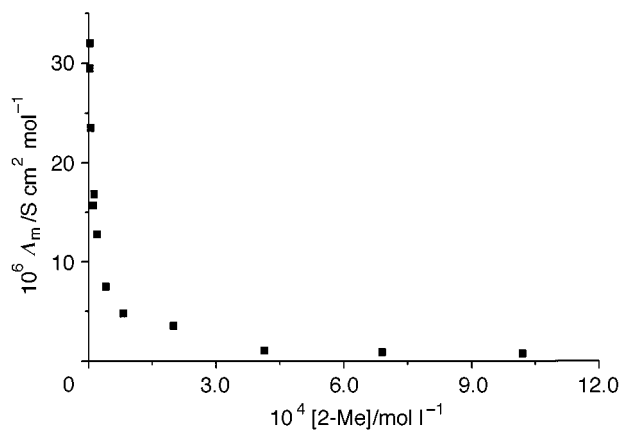
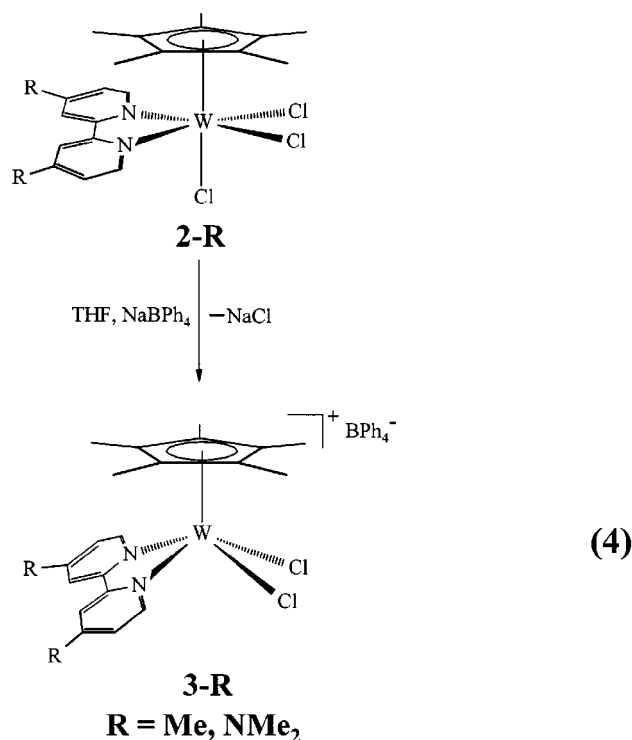

Fig. 2 Concentration dependent molar conductivity of complex **2-Me** in dichloromethane.



Synthesis of the cationic complexes 3-R

We had anticipated that the cationic complexes **3-R** might be directly obtained from compounds **2-R** by addition of NaX salts, where X = BPh₄[−], PF₆[−] or SbF₆[−], forcing the equilibrium (3) to the right through formation of insoluble sodium chloride, eqn. (4). Upon addition of NaBPh₄ to a violet solution of **2-Me** in dichloromethane according to eqn. (4) indeed an immediate change to dark green was noticed. From the reaction mixture, the cationic complex **3-Me** could be isolated as an analytically pure microcrystalline green solid in excellent yields. Conductivity measurements in dichloromethane at 10^{−3} and 10^{−4} M gave molar conductivity values of 32 and 58 S cm² mol^{−1}. This clearly evidenced that **3-Me** was a 1:1 electrolyte consistent with the description as a formal 16-electron complex. The NMR characterization was difficult due to the observed paramagnetism ($\mu_{\text{eff}} = 2.18 \mu_{\text{B}}$ at RT), which gives rise to broad and strongly shifted, temperature dependent ¹H NMR resonances. Since the NMR spectroscopy allowed little structural assignment, we have performed a single crystal X-ray diffraction study to establish the molecular structure of **3-Me**.

Crystal structure of complex 3-Me

Attempts to grow suitable single crystals of the cationic complexes were rather cumbersome and only successful for the

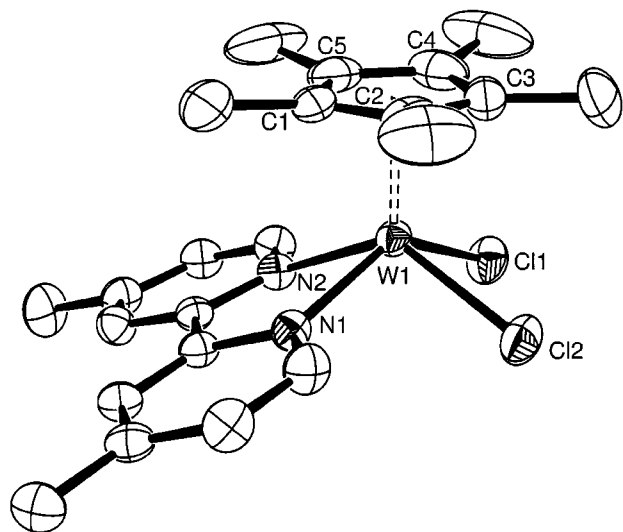

Fig. 3 Molecular structure of the cationic complex **3-Me**; the BPh_4^- counter ion has been omitted for clarity (ellipsoids are at the 50% probability level).

Table 2 Selected bond distances (\AA) and angles ($^\circ$) with e.s.d.s for complex **3-Me**

W1–C11	2.355(1)	W1–Cl2	2.366(1)
W1–N1	2.134(3)	W1–N2	2.143(2)
W1–C1	2.305(4)	W1–C2	2.302(3)
W1–C3	2.334(4)	W1–C4	2.405(4)
W1–C5	2.372(3)	W1–Z1 ^a	2.02
C–C (Cp^*) _{av}	1.408(5)		
C11–W1–Cl2	83.1(4)	C11–W1–N1	135.7(1)
C11–W1–N2	85.0(1)	Cl2–W1–N1	83.9(8)
Cl2–W1–N2	132.8(1)	N1–W1–N2	73.6(1)
C11–W1–Z1	110.7	Cl2–W1–Z1	113.7
N1–W1–Z1	113.4	N2–W1–Z1	113.3

^a Z1 is the midpoint of carbon atoms C1 to C5.

BPh_4^- salt, $[\text{WCp}^*(\text{Me}_2\text{bipy})\text{Cl}_2]^+\text{BPh}_4^-$ **3-Me**. The crystal structure of this complex is presented in Fig. 3; selected distances and angles are given in Table 2.

The shortest contact between the BPh_4^- counter ion and the W atom is 4.7 \AA which suggests that there is just coulombic interaction between the cationic metal complex and the anion. A formal 16-electron configuration can therefore be ascribed to **3-Me**. The complex adopts a square pyramidal structure, *i.e.* a four-legged piano stool structure, which is corroborated through the angles at the tungsten centre between the Cp^* centroid, Z1, and the bipyridyl and chloride ligands (C11–W1–Z1 110.7; Cl2–W1–Z1 113.7; N1–W1–Z1 113.4; N2–W1–Z1 113.3 $^\circ$). The bipyridyl donor and the chloride ligands form the basal ligands; the tungsten centre is located 0.087 \AA above the basal plane. As expected, the tungsten–chloride bonds W1–C11 2.355(1) and W1–Cl2 2.366(1) \AA in the cationic complex are significantly shorter than in the corresponding trichloro complex **2-Me** suggesting π donation of the chloride ligands to the Lewis acidic tungsten centre. In addition, stronger donation from the Cp^* ring to the metal centre is implied through the shorter $\text{Cp}^*_{\text{centroid}}\text{--W}$ distance (**3-Me**: W1–Z1 2.02 *vs.* 2.20 \AA in **2-Me**). Overall, the structural parameters of complex **3-Me** strongly resemble those reported by Poli³⁴ for the aforementioned cationic molybdenum $[\text{MoCp}(\text{PMe}_3)_2\text{Cl}_2]^+$ complex, which also displays a square pyramidal structure.

Reactivity of complex **3-Me**

The exceedingly high water sensitivity of the cationic complex **3-Me** imposed difficult problems to the study of its reaction

chemistry. Even under very careful conditions, *i.e.* using high vacuum and dry-box techniques and thoroughly dried solvents, the formation of the violet, diamagnetic, dinuclear μ -oxo, bis- μ -Cl bridged complex, $[\{\text{WCp}^*(\text{Me}_2\text{bipy})\}_2(\mu\text{-O})(\mu\text{-Cl})_2]^{2+}$ **4**,³⁵ was noticed in the presence of even trace amounts of water. So far, we were therefore restricted to reactions which proved to be sufficiently fast to intercept the *irreversible* formation of the undesired hydrolysed product **4**. The CO addition to complex **3-Me**, which quite surprisingly is only moderately fast and complete within 45 min at RT, fulfils this requirement and gives the cationic carbonyl complex **5-Me** in excellent yield, eqn. (5).

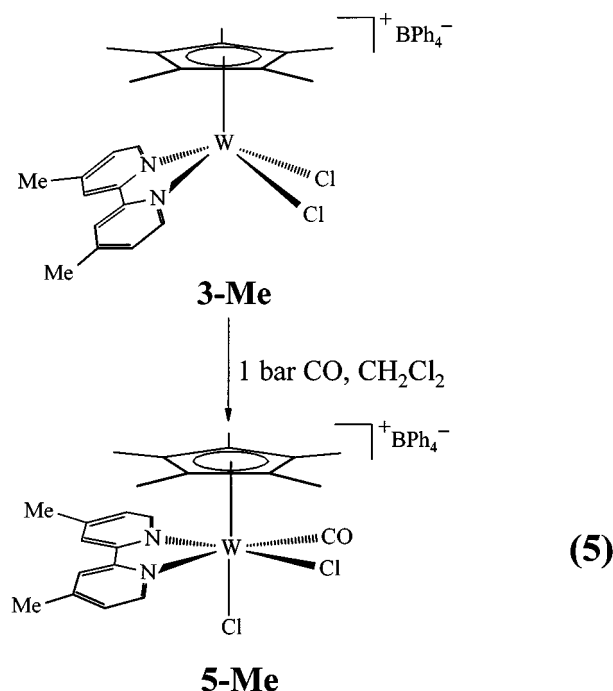

In contrast to the other mononuclear tungsten(IV) complexes described herein, the carbonyl complex **5-Me** is diamagnetic, as evidenced through sharp well resolved ^1H and ^{13}C NMR spectra. This quite likely reflects the larger ligand field splitting due to the carbonyl ligand. The inequivalence of the ^1H and ^{13}C NMR resonances of the equivalent positions in the bipyridyl rings immediately allowed us to establish that **5-Me** no longer possessed C_s symmetry. This clearly evidenced that the CO ligand was not incorporated into the vacant co-ordination site of the square-pyramidal complex, *i.e.* *trans* to the Cp^* ring, but rather was co-ordinated in the equatorial plane of the pseudo-octahedral complex. The IR spectrum displays a single stretching frequency at $\nu(\text{CO})$ 2004 cm^{-1} in the carbonyl range, which suggests sizeable back donation from the metal centre to the CO ligand and also rules out the presence of another isomer in solution. The spectroscopic assignment was confirmed later by the results of a crystal structure analysis (Fig. 4); selected bond lengths and angles in Table 3.

Crystal structure investigation of complex **5-Me**

Despite some minor crystallographic problems due to positional disorder of the equatorial CO and Cl ligands (see Experimental section for details), the equatorial position of the CO ligand in the carbonyl complex could be unambiguously demonstrated through the results of the crystal structure analysis. The co-ordination geometry around the tungsten centre in complex **5-Me** is best described as a pseudo-octahedron with the bipyridyl, the CO and Cl(1) ligands in the equatorial plane and the Cp^* ring and Cl(2) in the axial positions. The averaged W–Cl(1,2) distances of 2.42 \AA are intermediate between those found in the trichloro complex **2-Me** and the corresponding

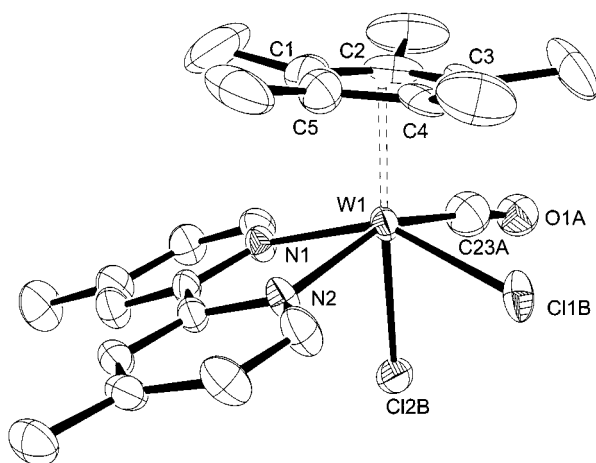

Fig. 4 Molecular structure of the carbonyl complex **5-Me**; only one of the disordered positions of atoms Cl1,2 and the carbonyl ligand are presented. The BPh_4^- counter ion has been omitted for clarity (ellipsoids are at the 50% probability level).

Table 3 Selected bond distances (Å) and angles (°) with e.s.d.s for complex **5-Me**

W1–Cl1a,b ^a	2.41	W1–Cl2a,b	2.45
W1–N1	2.187(3)	W1–N2	2.176(3)
W1–C1	2.394(6)	W1–C2	2.320(5)
W1–C3	2.295(6)	W1–C4	2.350(5)
W1–C6	2.432(6)	W1–C23a,b	2.00
C23a,b–O1a,b	1.14	W1–Z1 ^b	2.03
C–C (Cp*) _{av}	1.413(8)		
Cl1a,b–W1–Cl2a,b	78.4	N1–W1–N2	74.4(1)
C23a,b–W1–Cl1a,b	87.5	Cl2a,b–W1–C23a,b	75.9
W1–C23a,b–O1a,b	170.8		
Cl1a,b–W1–Z1	105.7	Cl2a,b–W1–Z1	171.4
N1–W1–Z1	105.1	N2–W1–Z1	106.0

^a Averaged values for disordered positions given. ^b Z1 is the midpoint of carbon atoms C1 to C5.

cationic complex **3-Me**, which implies that the CO ligand can remove electron density from the rather electron rich d^2 system.

In order to establish whether co-ordination of CO occurs initially at the axial position, which is then followed by isomerization (path a), or alternatively, through isomerization prior to CO addition (path b), we have monitored the reaction of **3-Me** with CO by variable temperature ^1H NMR spectroscopy. Within detection limits, we could only observe the resonances of the starting material **3-Me** and the product **5-Me** in these experiments, which suggests that the reaction proceeds *via* path b. It should be noted, however, that the absence of NMR signals arising from a (undetected) C_s symmetrical intermediate with the CO ligand in *trans* position to the Cp* ring does not completely rule out path a since the latter transient might just be present at very low concentration. Nevertheless, it is deemed that co-ordination of the CO ligand in the equatorial plane of complex **5-Me** is thermodynamically preferred on both (1) steric and (2) more relevant electronic grounds. Item (1) can be rationalized based on the steric encumbrance in the related trichloro complex **2-Me**, which has been used in the latter context to explain the out-of-plane bending of the Cp* methyl groups (see above). The smaller (slimmer) CO ligand thus can orient in a way that just one of the sterically more demanding Cl ligands is oriented in *cis* position to the Cp* ring. For item (2) it has to be considered that in an unperturbed octahedral d^2 system (O_h symmetry) the two electrons reside in the basal plane, the d_{xy} orbital. On these grounds π -back donation to the CO ligand can only be established if the CO group is co-ordinated in the basal plane.

Conclusion

We have demonstrated that bipyridyl substituted half-sandwich tungsten(IV) **2-Me** complexes are readily obtained through one electron reduction of the versatile starting material $[\text{WCp}^*\text{Cl}_4]$ in the presence of the bipyridyl donors. Facile ionization of one chloride ligand in these electron rich complexes allowed us to isolate the corresponding cationic tungsten(IV) complex **3-Me**. Most of the d^2 tungsten(IV) complexes described herein are paramagnetic; the investigation of the paramagnetic origin by both experimental and theoretical methods will be reported in due course.

Experimental

Reactions were carried out under a dinitrogen atmosphere with thoroughly dried solvents using glove-box and Schlenk techniques. The compounds $[\text{WCp}^*\text{Cl}_4]$,¹² $[\text{W}(\text{C}_5\text{Me}_4\text{Et})\text{Cl}_4]$,¹² $[\text{WCp}^*(\text{CO})_2\text{Cl}_3]$ ²⁴ and tBu_2bipy ³⁶ were prepared according to published methods. The rather cumbersome synthesis of $(\text{NMe}_2)_2\text{bipy}$ has been described previously.³⁷ We have prepared this ligand by a straightforward albeit low-yield (15%) route through reductive coupling of the commercially available *p*-dimethylaminopyridine with Raney nickel. The ^1H NMR and ^{13}C NMR spectra were recorded on Varian Gemini 200 and 300 spectrometers. Chemical shifts are given in ppm and referenced to the residual ^1H or ^{13}C NMR solvent shifts. The assignment of resonances is based on DEPT and selective ^1H NMR homo decoupling experiments. The IR spectra were measured on a Bio-Rad FTS-45 Fourier IR spectrometer. The CHN analyses were carried out with a LECO CHNS-932 elemental analyser in our institute. Some of the compounds contained solvents from recrystallization in the analytically pure material; this has been confirmed independently by integration of the solvent in the ^1H NMR spectrum. Conductivity measurements were performed with an Amel-160 conductometer using a glass cell with platinum electrodes ($K=1.0$). Magnetic moments have been determined at room temperature with a Johnson-Matthey laboratory magnetic susceptibility balance and were corrected for diamagnetic contributions.

Syntheses

$[\text{WCp}^*(\text{Me}_2\text{bipy})\text{Cl}_3]$ 2-Me. From $[\text{WCp}^*\text{Cl}_4]$. At room temperature, a solution of 183 mg (0.91 mmol) $(\text{NMe}_2)_2\text{C}=\text{C}(\text{NMe}_2)$ (TDAE) in 10 ml dichloromethane was added to an orange suspension of 842 mg (1.83 mmol) $[\text{WCp}^*\text{Cl}_4]$ and 336 mg (1.83 mmol) Me_2bipy in 100 ml dichloromethane upon which a change to dark violet was observed. The suspension was stirred for 1 h at this temperature, then filtered through a pad of Celite and the Celite washed with a small amount of CH_2Cl_2 . After concentration of the filtrate to *ca.* 40 ml the product was precipitated through addition of 40 ml of diethyl ether. The solid was collected by filtration, washed twice with ether and pentane and finally dried in high *vacuo* to give complex **2-Me** as an analytically pure violet microcrystalline solid. Yield: 1.01 g, 1.66 mmol, 91% (based on $[\text{WCp}^*\text{Cl}_4]$). ^1H NMR (CD_2Cl_2 , RT, 300 MHz): δ 8.7 (br, $\omega_{1/2} \approx 32$, 2 H, Me_2bipy), 8.1 (br, $\omega_{1/2} \approx 13$, 2 H, Me_2bipy), 7.5 (br, $\omega_{1/2} \approx 13$, 2 H, Me_2bipy), 2.8 (br, $\omega_{1/2} \approx 24$, 6 H, Me_2bipy) and 1.7 (br, $\omega_{1/2} \approx 6$ Hz, 15 H, C_5Me_5). MS (EI): m/z 608 ($\text{M}^+ - 2\text{H}$) and 575 ($\text{M}^+ - \text{Cl}$) (Calc. for $\text{C}_{22}\text{H}_{27}\text{Cl}_3\text{N}_2\text{W}$: C, 43.34; H, 4.46; N, 4.59. Found: C, 43.13; H, 4.30; N, 4.50%).

From $[\text{WCp}^*(\text{CO})_2\text{Cl}_3]$. A suspension of 80 mg (0.170 mmol) $[\text{WCp}^*(\text{CO})_2\text{Cl}_3]$ and 31 mg (0.170 mmol) Me_2bipy in 20 ml toluene was heated in vacuum for 6 h to 110 °C leading to a change from yellow to dark brown. After this time the reaction mixture was allowed to cool to RT, the solid collected by centrifugation and washed with small portions of ether until the washing solutions remained colourless. The residue was then dried in high *vacuo* and recrystallized at -36 °C from a pentane

layered solution of the crude product in CH_2Cl_2 . Yield: 66 mg, 64%.

[W($\eta^5\text{-C}_5\text{Me}_4\text{Et})(\text{Me}_2\text{bipy})\text{Cl}_2] 2^{\text{Et-Me}}$. A solution of 58 mg (0.290 mmol) TDAE in 3 ml dichloromethane was slowly dropped on to a solution of 276 mg (0.581 mmol) $[\text{W}(\eta^5\text{-C}_5\text{Me}_4\text{Et})\text{Cl}_4]$ and 108 mg (0.587 mmol) Me_2bipy in 15 ml CH_2Cl_2 at RT giving a violet suspension which was stirred for 1 h at RT. Upon filtration through Celite the filtrate was concentrated to ca. 10 ml, then cooled to -36°C . At this temperature complex **2^{Et-Me}** was obtained as violet needles which were isolated by decantation of the mother-liquor. The crystals were washed with a small amount of pentane, then dried in high *vacuo* to give 309 mg, 0.495 mmol, 85% **2^{Et-Me}** {based on $[\text{W}(\eta^5\text{-C}_5\text{Me}_4\text{Et})\text{Cl}_4]$. Crystals suitable for X-ray diffraction were obtained by slow diffusion of diethyl ether into a solution of **2^{Et-Me}** in dichloromethane at room temperature. ^1H NMR (CD_2Cl_2 , RT, 300 MHz): δ 8.6 (br, $\omega_{1/2} \approx 69$, 2 H, Me_2bipy), 8.1 (br, $\omega_{1/2} \approx 11$, 2 H, Me_2bipy), 7.5 (br, $\omega_{1/2} \approx 23$, 2 H, Me_2bipy), 2.9 (br, $\omega_{1/2} \approx 56$ Hz, 6 H, Me_2bipy), 1.80 (s, 6 H, $\text{C}_5\text{Me}_4\text{Et}$), 1.75 (s, 6 H, $\text{C}_5\text{Me}_4\text{Et}$), 1.45 (q, 2 H, $\text{C}_5\text{Me}_4\text{CH}_2\text{CH}_3$, $J = 7$) and 1.03 (t, 3 H, $\text{C}_5\text{Me}_4\text{CH}_2\text{CH}_3$, $J = 7$ Hz) (Calc. for $\text{C}_{23}\text{H}_{29}\text{Cl}_3\text{N}_2\text{W}$: C, 44.29; H, 4.69; N, 4.49. Found: C, 44.18; H, 4.72; N, 4.64%).

[WCp*(tBu₂bipy)Cl₂] 2-tBu. To a suspension of 1.73 g (3.75 mmol) $[\text{WCp}^*\text{Cl}_4]$ and 1.01 g (3.77 mmol) tBu₂bipy in 150 ml CH_2Cl_2 , a solution of 375 mg (1.88 mmol) TDAE in 15 ml CH_2Cl_2 was slowly added at RT. After stirring for 1 h the violet suspension was filtered through Celite and the volume of filtrate reduced to ca. 50 ml *in vacuo*. Upon addition of 100 ml diethyl ether to the filtrate the product precipitated and was collected by filtration and washed with ether and pentane. The solid was finally dried in high *vacuo* to yield 2.47 g, 3.56 mmol, 95% **2-tBu** based on $[\text{WCp}^*\text{Cl}_4]$. ^1H NMR (CD_2Cl_2 , RT, 300 MHz): δ 8.8 (br, $\omega_{1/2} \approx 35$, 2 H, tBu₂bipy), 8.2 (br, $\omega_{1/2} \approx 10$, 2 H, tBu₂bipy), 7.7 (br, $\omega_{1/2} \approx 40$, 2 H, tBu₂bipy), 1.71 (br, $\omega_{1/2} \approx 15$ Hz, 15 H, C_5Me_5) and 1.45 (s, 18 H, CMe_3). MS (EI): *m/z* 692 (M^+) and 657 ($\text{M}^+ - \text{Cl}$) (Calc. for $\text{C}_{28}\text{H}_{39}\text{Cl}_3\text{N}_2\text{W}$: C, 48.47; H, 5.67; N, 4.04. Found: C, 48.10; H, 5.49; N, 4.07%).

[WCp*(NMe₂)₂bipy]Cl₂ 2-NMe₂. A solution of 76 mg (0.38 mmol) TDAE in 20 ml dichloromethane was added dropwise to a solution of 350 mg (0.76 mmol) $[\text{WCp}^*\text{Cl}_4]$ and 185 mg (0.76 mmol) (NMe₂)₂bipy in 60 ml CH_2Cl_2 giving a yellow-orange suspension. After stirring for 2 h at RT the reaction mixture was filtered through a pad of Celite and washed with a small amount of CH_2Cl_2 . The collected filtrates were concentrated *in vacuo* to ca. 10 ml, upon which the product precipitated as a yellow-orange solid; precipitation was completed through addition of 40 ml ether. The solid was collected by filtration, washed with toluene and ether and finally dried in high vacuum. Yield: 450 mg, 0.67 mmol, 89% based on $[\text{WCp}^*\text{Cl}_4]$. ^1H NMR (CD_2Cl_2 , 298 K): δ 8.37 [d, $^4J = 2$, 2 H, (NMe₂)₂bipy], 7.46 [m, 2 H, (NMe₂)₂bipy], 7.0 [d, $^3J = 7$ Hz, 2H, (NMe₂)₂bipy], 4.84 [br, $\omega_{1/2} = 20$, 12 H, (NMe₂)₂bipy] and 2.61 (br, $\omega_{1/2} = 6$ Hz, 15 H, C_5Me_5) (Calc. for $\text{C}_{24}\text{H}_{33}\text{Cl}_3\text{N}_4\text{W}$: C, 43.17; H, 4.98; N, 8.39. Found: C, 43.22; H, 5.25; N, 8.01%).

[WCp*(Me₂bipy)Cl₂]⁺BPh₄⁻ 3-Me. A solution of 1.05 g (3.08 mmol) NaBPh₄ in 30 ml THF was added to a stirred suspension of 1.88 g (3.08 mmol) $[\text{WCp}^*(\text{Me}_2\text{bipy})\text{Cl}_3]$ in 100 ml THF at RT. After stirring for 30 min at this temperature a clear brown solution was obtained which was evacuated to dryness. The residue was extracted into 150 ml of 1,2-dichloroethane and filtered through a fine porous frit covered with a pad of Celite. After concentration of the green filtrate to 80 ml *in vacuo*, 180 ml ether were slowly added. From this mixture, the product crystallized overnight as a microcrystalline dark green solid at RT. The mother-liquor was decanted off, the solid washed with ether and finally dried in high vacuum to give 2.1 g,

2.35 mmol **3-Me**, 76% based on $[\text{WCp}^*(\text{Me}_2\text{bipy})\text{Cl}_3]$. Single crystals suitable for X-ray diffraction were obtained at RT by crystallization from an ether-1,2-dichloroethane solution. ^1H NMR (CD_2Cl_2 , 300 MHz, 293 K): δ 106 (br, $\omega_{1/2} \approx 105$), 43 (br, $\omega_{1/2} \approx 40$), 28 (br, $\omega_{1/2} \approx 30$), 17.5 (br, $\omega_{1/2} \approx 40$), 7.4 (m, 8 H, BPh₄⁻), 7.0 (m, 8 H, BPh₄⁻), 6.9 (m, 4 H, BPh₄⁻) and -85 (br, $\omega_{1/2} \approx 110$ Hz). MS: FAB⁺ *m/z* 535 ($\text{M}^+ - \text{Cl}$); FAB⁻ *m/z* 319 (BPh₄⁻). Molar conductivity, $\Lambda_m(\text{CH}_2\text{Cl}_2)$: $c = 10^{-4}$, 58; 10^{-3} M, 32 S cm² mol⁻¹ (Calc. for $\text{C}_{46}\text{H}_{47}\text{BCl}_2\text{N}_2\text{W}$: C, 61.84; H, 5.30; N, 3.14. Found: C, 61.49; H, 5.33; N, 3.10%).

[WCp*(NMe₂)₂bipy]Cl₂[BPh₄] 3-NMe₂. A solution of 102 mg NaBPh₄ (0.30 mmol) in 10 ml THF was added to a suspension of 199 mg (0.30 mmol) $[\text{WCp}^*(\text{NMe}_2)_2\text{bipy}]\text{Cl}_3$ in 10 ml THF. After stirring for 30 min at RT the reaction mixture was evaporated to dryness in high vacuum. The residue was extracted into 15 ml 1,2-dichloroethane, and filtered through a fine frit covered with a pad of Celite. Diethyl ether was added to the filtrate until precipitation of the product was observed. Overnight the product crystallized from this mixture as a dark green microcrystalline solid. The solid was collected by filtration, washed with ether and dried in high vacuum. Yield: 160 mg, 0.17 mmol, 56% based on $[\text{WCp}^*(\text{NMe}_2)_2\text{bipy}]\text{Cl}_3$. ^1H NMR (CD_2Cl_2 , 293 K): δ 8.64 [dd, $^3J = 7$, $^4J = 2$, 2 H, (NMe₂)₂bipy], 7.31 (m, 8 H, BPh₄⁻), 7.01 (m, 8 H, BPh₄⁻), 6.85 (m, 4 H, BPh₄⁻), 6.58 [d, $^4J = 2$ Hz, 2 H, (NMe₂)₂bipy], 6.30 [br, $\omega_{1/2} = 30$, 6 H, (NMe₂)₂bipy], 5.85 [br, $\omega_{1/2} = 30$ Hz, 6 H, (NMe₂)₂bipy], 4.85 [d, $^3J = 7$ Hz, 2 H, (NMe₂)₂bipy] and 3.26 (s, $\omega_{1/2} = 4$ Hz, 15 H, C_5Me_5) (Calc. for $\text{C}_{48}\text{H}_{53}\text{BCl}_2\text{N}_4\text{W}\cdot\text{CH}_2\text{Cl}_2$: C, 56.78; H, 5.35; N, 5.41. Found: C, 56.40; H, 5.22; N, 5.39%).

[WCp*(Me₂bipy)(CO)Cl₂]⁺BPh₄⁻ 5-Me. In the dry-box, 363 mg (0.41 mmol) $[\text{WCp}^*(\text{Me}_2\text{bipy})\text{Cl}_2]^+\text{BPh}_4^-$ **3-Me** were dissolved in 30 ml 1,2-dichloroethane in a 200 ml high-vacuum Young tap-sealed Schlenk tube and transferred to a high vacuum manifold. The solution was frozen out at liquid nitrogen temperature, evacuated, then refilled with 1 bar of carbon monoxide and warmed to RT. Within 45 min of stirring at this temperature a change from dark green to red was observed. After stirring for 90 min the solution was concentrated to 10 ml *in vacuo* and the product precipitated as a microcrystalline orange-red solid by slow addition of diethyl ether. It was collected by filtration, washed twice with ether and pentane, then dried in high *vacuo*. The CO complex **5-Me** is insoluble in THF but dissolves well in CH_2Cl_2 . Yield: 325 mg, 0.35 mmol, 87%. ^1H NMR (CD_2Cl_2 , 300 MHz, 293 K): δ 9.03 (d, $^3J = 6$, 1 H, Me_2bipy), 8.33 (d, 1 H, $^3J = 6$, Me_2bipy), 7.91 (m, 1 H, Me_2bipy), 7.89 (m, 1 H, Me_2bipy), 7.56 (dd, $^3J = 6$, $^4J = 2$, 1 H, Me_2bipy), 7.35 (m, 8 H, BPh₄⁻), 7.28 (dd, $^3J = 6$, $^4J = 2$ Hz, 1 H, Me_2bipy), 6.99 (m, 8 H, BPh₄⁻), 6.83 (m, 4 H, BPh₄⁻), 2.52 (s, 3 H, Me_2bipy), 2.48 (s, 3 H, Me_2bipy) and 1.78 (s, 15 H, C_5Me_5). ^{13}C -{ ^1H } NMR (CD_2Cl_2 , 75.4 MHz, 298 K): δ 214.1 (s, CO), 164.3 [q, B(C₆H₅)₄⁻, $^1J_{\text{B-C}} = 50$], 156.8 (s, quart. C_{arom}, Me_2bipy), 156.1 (s, quart. C_{arom}, Me_2bipy), 155.7 (s, CH_{arom}, Me_2bipy), 154.9 (s, quart. C_{arom}, Me_2bipy), 154.5 (s, quart. C_{arom}, Me_2bipy), 149.7 (s, CH_{arom}, Me_2bipy), 136.4 [q, CH_{arom}, B(C₆H₅)₄⁻, $J_{\text{B-C}} = 2$], 131.3 (s, CH_{arom}, Me_2bipy), 129.8 (s, CH_{arom}, Me_2bipy), 126.4 (s, CH_{arom}, Me_2bipy), 126.2 [q, CH_{arom}, B(C₆H₅)₄⁻, $J_{\text{B-C}} = 3$ Hz], 122.3 [q, CH_{arom}, B(C₆H₅)₄⁻], 110.2 (s, quart. C_{arom}, C_5Me_5), 22.2 (s, Me_2bipy), 22.0 (s, Me_2bipy) and 10.9 (s, C_5Me_5). IR (CH_2Cl_2): $\nu(\text{CO})$ 2004 cm⁻¹ (Calc. for $\text{C}_{47}\text{H}_{47}\text{BCl}_2\text{N}_2\text{OW}\cdot\text{C}_2\text{H}_4\text{Cl}_2$: C, 57.68; H, 5.04; N, 2.75. Found: C, 58.04; H, 4.66; N, 2.70%). Single crystals suitable for X-ray diffraction were obtained by slow diffusion of ether into a solution of **5-Me** in 1,2-dichloroethane at RT.

Crystal structure analyses

General remarks. Suitable single crystals of complexes **2^{Et-Me}**, **3-Me** and **5-Me** were mounted on a glass fibre in Paratone-N

Table 4 Crystal and data collection parameters for compounds **2^{Et}-Me**, **3-Me** and **5-Me**

	2^{Et}-Me	3-Me	5-Me
Formula	C ₂₃ H ₂₉ Cl ₃ N ₂ W·2CH ₂ Cl ₂	C ₄₆ H ₄₇ BCl ₂ N ₂ W	C ₄₇ H ₄₇ BCl ₂ N ₂ OW·C ₂ H ₄ Cl ₂
<i>M</i>	793.5	893.4	1020.4
Crystal system	Monoclinic	Monoclinic	Monoclinic
Space group	<i>P</i> 2 ₁ / <i>n</i> (no. 14)	<i>P</i> 2 ₁ / <i>c</i> (no. 14)	<i>P</i> 2 ₁ / <i>n</i> (no. 14)
<i>a</i> /Å	8.324(1)	11.672(1)	22.428(2)
<i>b</i> /Å	17.879(3)	16.362(2)	9.264(1)
<i>c</i> /Å	20.464(4)	21.122(2)	23.646(2)
β /°	100.92(1)	99.61(1)	115.13(1)
<i>V</i> /Å ³	2990.4(9)	3977.2(7)	4448.0(7)
<i>Z</i>	4	4	4
μ /mm ⁻¹	4.50	3.07	2.88
<i>T</i> /K	193	193	193
2θ range/°	4–52	4–52	4–52
No. measured reflections (total, unique)	5749, 5339	36931, 7678	34876, 8462
<i>R</i> 1 [<i>F</i> ² > 2σ(<i>F</i> ²)]	0.0563	0.0192	0.0280
<i>wR</i> 2 [<i>F</i> ² > 2σ(<i>F</i> ²)]	0.1463	0.0372	0.0770

(oil), transferred on the goniometer head to the diffractometer and cooled to $-80\text{ }^{\circ}\text{C}$ in a nitrogen cryostream. The data sets were collected with graphite monochromated Mo-K α radiation (λ 0.71073 Å) on Siemens P4 four-circle (**2^{Et}-Me**) and Stoe IPDS image plate diffractometers (**3-Me** and **5-Me**). Intensities were corrected for Lorentz-polarization effects and absorption corrections performed either empirically from ψ scans (**2^{Et}-Me**) or numerically with the faces and corresponding crystal dimensions determined using the STOE Faceit-Video CCD camera microscope system (**3-Me** and **5-Me**). The structures were solved using direct methods with the SHELXS 86 program package.³⁸ The refinements were carried out with SHELXL 93 using all unique *F*_o².³⁹ Except for complex **5-Me** all non-hydrogen atoms were refined anisotropically. The positions of the hydrogen atoms were calculated in idealized positions (C–H bonds fixed at 0.96 Å) and refined as a riding model with a fixed isotropic displacement factor of *U* = 0.08 Å². The details of the data collection and refinement including *R* values are summarized in Table 4.

Complex 5-Me. One disordered molecule of 1,2-dichloroethane from recrystallization was contained per molecule of complex and was refined with two split positions with occupation factors of 0.55 and 0.45 for the disordered Cl3 atom. The CO ligand and atom Cl1 were positionally disordered; this was indicated in the Fourier-difference map through a large peak between the C23–O1 bond vector and by another peak located on the W1–Cl1 axis (distant from W1) in close proximity to Cl1 (0.56 Å apart from Cl1). The disorder was resolved and refined with split positions for atoms C23 and O1 (denoted as C23a,b and O1a,b) and two split positions for Cl1, denoted as Cl1a,b, with their occupational parameters refined as an independent variable. The positions of C23a,b and O1a,b were refined isotropically using identical displacement parameters (EADP card) while Cl1a,b was treated anisotropically. The refinement of the occupational parameter converged at final values of 0.44 and 0.56. In addition, a strong thermal mobility of Cl2 was noticed. This could be refined with two split positions, *i.e.* Cl2a,b, and using the occupational parameters obtained for the aforementioned positional disorder of the CO and Cl1 ligands. The residual non-hydrogen atoms were refined anisotropically; the positions of the hydrogen atoms were calculated in idealized positions and refined as above.

CCDC reference number 186/1438.

See <http://www.rsc.org/suppdata/dt/1999/1967/> for crystallographic files in .cif format.

Acknowledgements

We are indebted to Professor Heinz Berke for his generous

support. We thank Mr Thomas Hildebrand for working out the details of the synthesis of (NMe₂)₂bipy. Funding of this project by the Swiss National Science Foundation is gratefully acknowledged.

References

- R. Poli, *Chem. Rev.*, 1991, **91**, 509.
- J. U. Desai, J. C. Gordon, H.-B. Kraatz, V. T. Lee, B. E. Owens-Waltermire, R. Poli, A. L. Rheingold and C. B. White, *Inorg. Chem.*, 1994, **33**, 3752.
- F. Abugideiri, J. C. Gordon, R. Poli, B. E. Owens-Waltermire and A. L. Rheingold, *Organometallics*, 1993, **12**, 1575.
- F. Abugideiri, G. A. Brewer, J. U. Desai, J. C. Gordon and R. Poli, *Inorg. Chem.*, 1994, **33**, 3745.
- R. Poli and M. A. J. Kelland, *Organomet. Chem.*, 1991, **419**, 127.
- S. T. Krueger, R. Poli, A. L. Rheingold and D. L. Staley, *Inorg. Chem.*, 1989, **28**, 4599.
- S. T. Krueger, B. E. Owens and R. Poli, *Inorg. Chem.*, 1990, **29**, 2001.
- B. E. Owens and R. Poli, *Inorg. Chim. Acta*, 1991, **179**, 229.
- R. R. Schrock, A. H. Liu, M. B. O'Regan, W. C. Finch and J. F. Payack, *Inorg. Chem.*, 1988, **27**, 3574.
- R. R. Schrock, T. E. Glassman, M. G. Vale and M. Kol, *J. Am. Chem. Soc.*, 1993, **115**, 1760.
- M. B. O'Regan, A. H. Liu, W. C. Finch, R. R. Schrock and W. M. Davis, *J. Am. Chem. Soc.*, 1990, **112**, 4331.
- R. C. Murray, L. Blum, A. H. Liu and R. R. Schrock, *Organometallics*, 1985, **4**, 953.
- X. Morise, M. L. H. Green, P. C. McGowan and S. J. Simpson, *J. Chem. Soc., Dalton Trans.*, 1994, 871.
- A. H. Liu, R. C. Murray, J. C. Dewan, B. D. Santarsiero and R. R. Schrock, *J. Am. Chem. Soc.*, 1987, **109**, 4282.
- M. L. H. Green, J. D. Hubert and P. Mountford, *J. Chem. Soc., Dalton Trans.*, 1990, 3793.
- M. L. H. Green, A. Izquierdo, J. J. Martin-Polo, V. S. B. Mtetwa and K. Prout, *J. Chem. Soc., Chem. Commun.*, 1983, 538.
- R. R. Schrock, S. F. Pedersen, M. R. Churchill and J. W. Ziller, *Organometallics*, 1984, **3**, 1574.
- M. L. H. Green and P. Mountford, *Chem. Soc. Rev.*, 1992, 29.
- T. E. Glassman, M. G. Vale and R. R. Schrock, *Inorg. Chem.*, 1992, **31**, 1985.
- S. J. Holmes and R. R. Schrock, *Organometallics*, 1983, **2**, 1463.
- Q. Feng, M. Ferrer, M. L. H. Green, P. Mountford and V. S. B. Mtetwa, *J. Chem. Soc., Dalton Trans.*, 1992, 1205.
- Q. Feng, M. Ferrer, M. L. H. Green, P. Mountford, V. S. B. Mtetwa and K. Prout, *J. Chem. Soc., Dalton Trans.*, 1991, 1397.
- R. T. Baker, J. C. Calabrese, R. L. Harlow and I. D. Williams, *Organometallics*, 1993, **12**, 830.
- H. Blackburn, H.-B. Kraatz, R. Poli and R. C. Torralba, *Polyhedron*, 1995, **14**, 2225.
- E. R. Burckhardt, J. J. Doney, R. G. Bergman and C. H. Heathcock, *J. Am. Chem. Soc.*, 1987, **109**, 2022.
- C. Cremer, H. Jacobsen and P. Burger, *Chimia*, 1997, **51**, 650.
- R. J. Haines, R. S. Nyholm and M. H. B. Stiddard, *J. Chem. Soc. A*, 1966, 1606.
- G. S. B. Adams and M. L. H. Green, *J. Chem. Soc., Dalton Trans.*, 1981, 353.

- 29 K. Stärker and M. D. Curtis, *Inorg. Chem.*, 1985, **24**, 3006.
30 C. K. Johnson, ORTEP, Report ORNL-5138, Oak Ridge National Laboratory, Oak Ridge, TN, 1976.
31 P. Kubáček, R. Hoffmann and Z. Havlas, *Organometallics*, 1982, **1**, 180.
32 A. G. Orpen, L. Brammer, F. H. Allen, O. Kennard, D. G. Watson and R. Taylor, *J. Chem. Soc., Dalton Trans.*, 1989, S1.
33 W. J. Geary, *Coord. Chem. Rev.*, 1971, **7**, 81.
34 R. Poli, *Chem. Rev.*, 1996, **96**, 2135.
35 C. Cremer and P. Burger, unpublished work.
36 G. M. Badger and W. H. F. Sasse, *J. Chem. Soc.*, 1956, 616.
37 P. Wehman, G. C. Dol, E. R. Moorman, P. C. J. Kramer and P. W. N. M. van Leeuwen, *Organometallics*, 1994, **13**, 4856.
38 G. M. Sheldrick, SHELXTL PLUS, University of Göttingen, 1988.
39 G. M. Sheldrick, SHELXL 93, University of Göttingen, 1993.

Paper 9/02743B